

TBM1010

SINGLE PHASE 10.0 AMPS. GLASS PASSIVATED BRIDGE RECTIFIERS

FEATURE

- . Surface mount bridge, small package;
- . Glass passivated junction.
- . Ideal for printed circuit board.
- . Reliable low cost construction utilizing molded plastic technique.
- . High surge current capability.
- . High temperature soldering guaranteed: 260°C/10 seconds at terminals.
- . Qualified to AEC-Q101 Standards for High Reliability

MECHANICAL DATA

- . Case Material: "Green" Molding compound, UL flammability classification rating 94V-0
- . Moisture sensitivity level: level 2a, per J-STD-020
- . Polarity: Polarity as marked on the body
- . Weight: 0.415g (approximately)

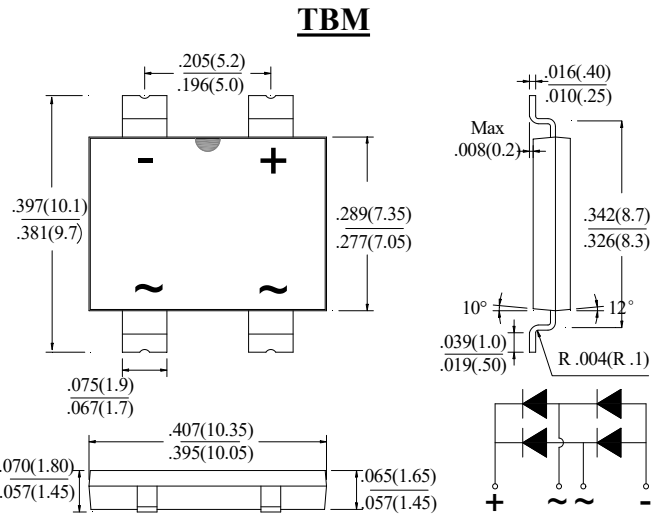

Dimensions in inches and (millimeters)

MAXIMUM RATINGS AND ELECTRICAL CHARACTERISTICS

Ratings at 25°C ambient temperature unless otherwise specified.

Single phase, half wave, 60Hz, resistive or inductive load. For capacitive load, derate current by 20%

Type Number	SYM BOL	TBM1010			units
Maximum Recurrent Peak Reverse Voltage	V_{RRM}	1000			V
Maximum RMS Voltage	V_{RMS}	700			V
Maximum DC blocking Voltage	V_{DC}	1000			V
Maximum Average Forward rectified Current	$I_{F(AV)}$	10.0			A
Peak Forward Surge Current @ $T_J=25^\circ\text{C}$ 8.3ms single half sine-wave @ $T_J=125^\circ\text{C}$	I_{FSM}	200			A
Peak Forward Surge Current @ $T_J=25^\circ\text{C}$ 1.0ms single half sine-wave @ $T_J=125^\circ\text{C}$		170			
Maximum Instantaneous Forward Voltage @ $I_F=5.0\text{A DC}$	V_F	1.1			V
Maximum DC Reverse Current @ $T_J=25^\circ\text{C}$ at rated DC blocking voltage @ $T_J=125^\circ\text{C}$	I_R	5.0 200.0			μA
I^2t Rating for Fusing ($t < 8.3\text{ms}$)	I^2t	166			A^2Sec
Typical Junction Capacitance Per Leg (Note1)	C_J	55			pF
Typical Thermal Resistance (without Heatsink)	R_{JA}	R_{JA}	R_{JL}	R_{JC}	$^\circ\text{C/W}$
Typical Thermal Resistance (Note2)		55	8	7	
Storage Temperature	T_{STG}	-55 to +150			$^\circ\text{C}$
Operating Junction Temperature	T_J	-55 to +150			$^\circ\text{C}$

Note:

1. Measured at 1.0 MHz and applied reverse voltage of 4.0Vdc
2. Thermal resistance junction to case, lead and ambient in accordance with JESD-51.

Unit mounted on 15mm x 12mm x 1.6mm AL Pad attached on 100mm x 100mm x 30mm copper plate

Ratings and Characteristics Curves

FIG.1-TYPICAL FORWARD CURRENT DERATING CURVE

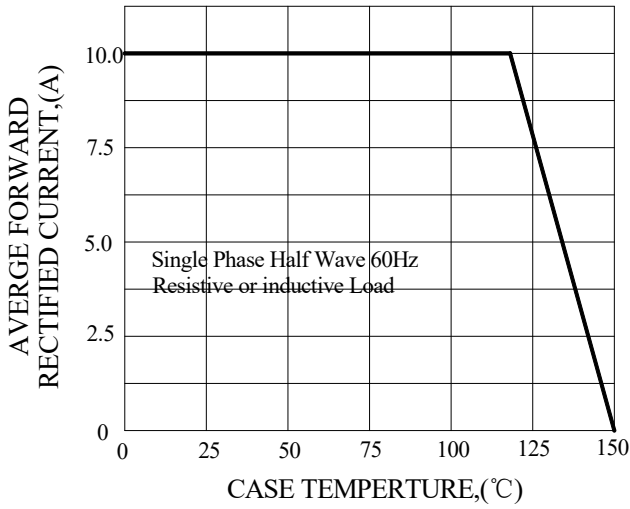

FIG.2-TYPICAL INSTANTANEOUS FORWARD CHARACTERISTICS

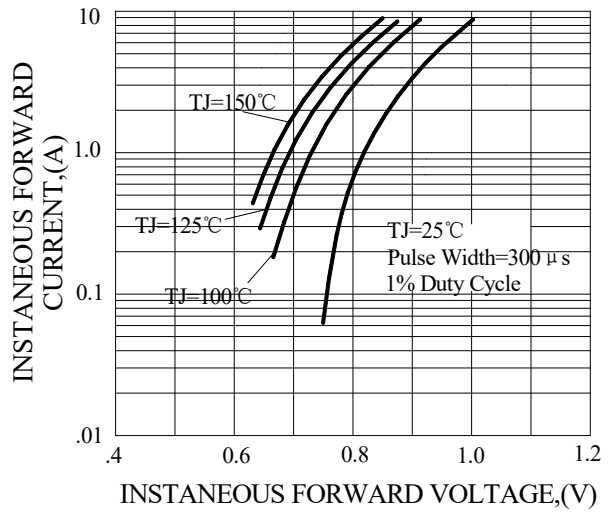

FIG.3-MAXIMUM NON-REPETITIVE FORWARD SURGE CURRENT

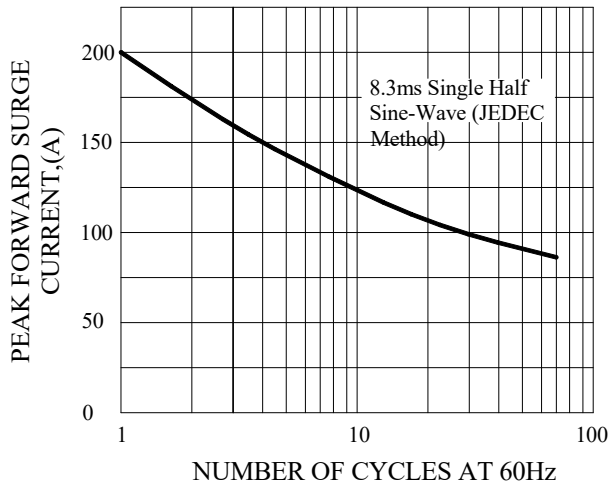

FIG.4-TYPICAL JUNCTION CAPACITANCE

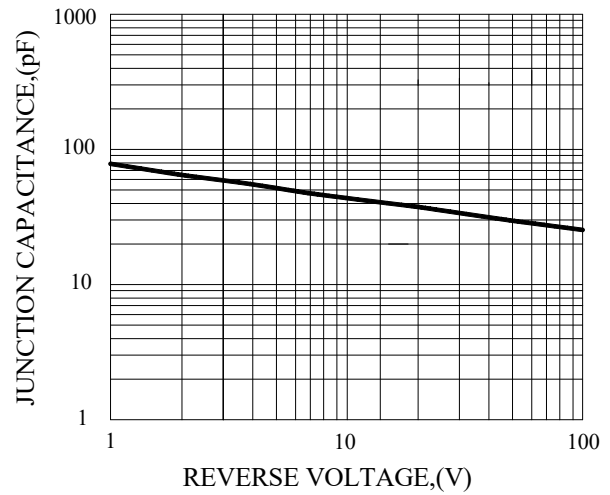
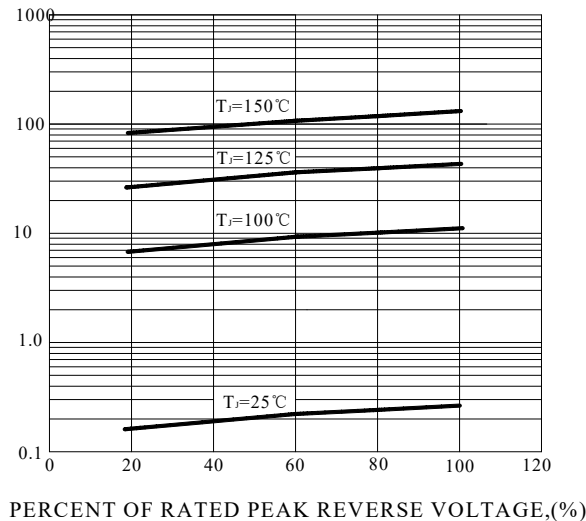
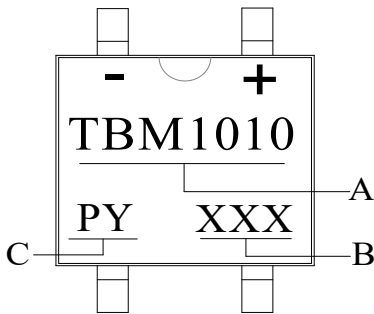

FIG.5-TYPICAL REVERSE CHARACTERISTICS



Marking、 Pad Layout 、 MOQ and packaging illustration

1、 Marking



SYMBOL	Explanation
A	Product Name
B	Date Code
C	Trademark

2、 Suggested Pad Layout (mm)

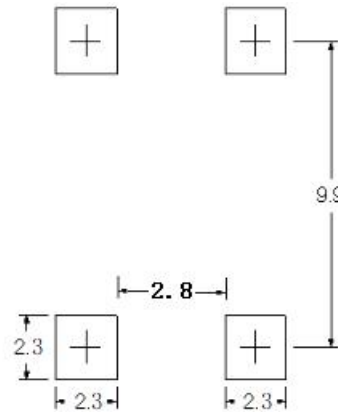

3、 MOQ

1500pcs / Tape & Reel

4、 Packaging

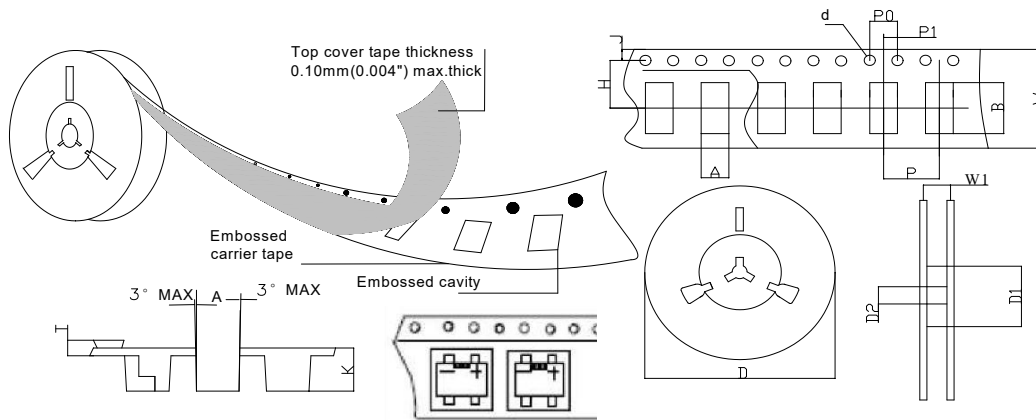

SPECIFICATIONS mm(inch)		PACKAGE	SPECIFICATIONS mm(inch)		PACKAGE
ITEM	SYM BOL	TBM	ITEM	SYM BOL	TBM
Carrier width	A	10.5(0.413)Max	Carrier depth	K	2.25(0.088)Typ
Carrier length	B	11.0(0.433)Max	Punch hole pitch	P	16.00(0.630)Typ
Sprocket hole	d	ø1.6(0.063)Typ	Sprocket hole pitch	P0	4.00(0.157)Typ
Reel outer diameter	D	330.0(13.0)Typ	Embossment center	P1	2.00(0.079)Typ
Reel inner diameter	D1	75.0(2.953)Min	Overall tape thickness	T	0.30(0.012)Typ
Feed hole diameter	D2	13.0(0.512)Typ	Tape width	W	24.0(0.945)Typ
Sprocket hole position	J	1.75(0.069)Typ	Reel width	W1	25.5(1.004)Min
Punch hole position	H	11.50(0.452)Typ			